



SX112 TOURMAX

QUICKSTART GUIDE
ENGLISH

GUÍA DE INICIO RÁPIDO
ESPAÑOL

GUIDE D'UTILISATION RAPIDE
FRANÇAIS

GUIDA RAPIDA
ITALIANO

SCHNELLSTART-ANLEITUNG
DEUTSCH

SNELSTARTGIDS
NEDERLANDS

BOX CONTENTS

- TOURMAX speaker
- Quickstart Guide
- Safety Instructions & Warranty Information Booklet

CONNECTION DIAGRAM

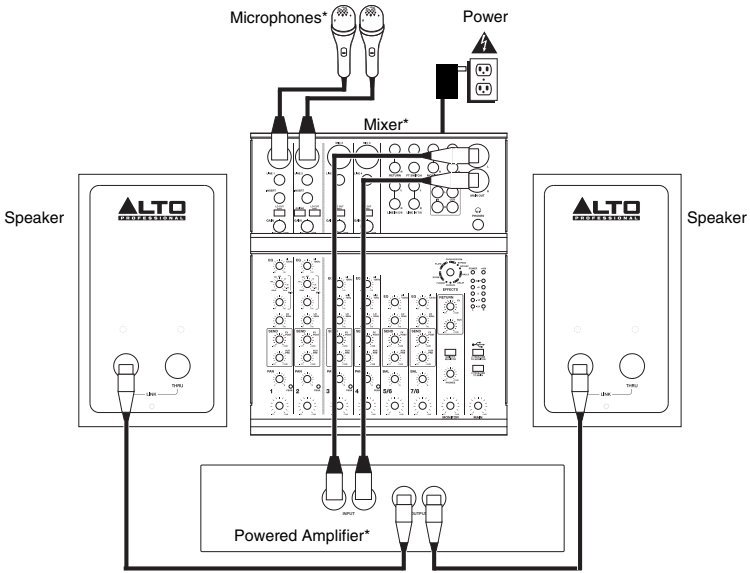

**Note: Microphones, mixer, amp, and cables are not included.*

INSTALLATION

This speaker should be installed securely on a stand on the floor, according to its maximum weight, or suspended from its suspension points (M10 x 1.5PH, 30mm length) (see image for an example). We do NOT recommend suspending multiple speakers in a vertical array.

Example:

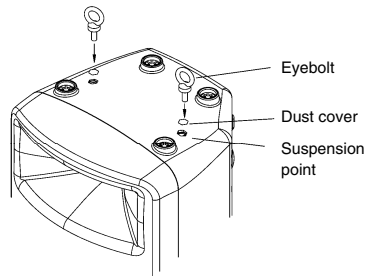

REAR PANEL OVERVIEW

1. **INPUT** – Use a standard Speakon® cable (not included) to connect your powered amplifier to this input.
2. **THRU** – Use a standard Speakon cable (not included) to connect this jack to the input of another speaker (i.e., another TOURMAX speaker).

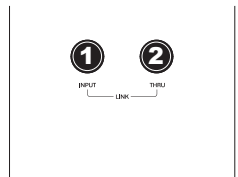

** Speakon is a trademark of Neutrik® AG, registered in the U.S. and other countries.*

CONTENIDO DE LA CAJA

- Altavoz TOURMAX
- Guía de inicio rápido
- Folleto de instrucciones de seguridad e información sobre la garantía

DIAGRAMA DE CONEXIÓN

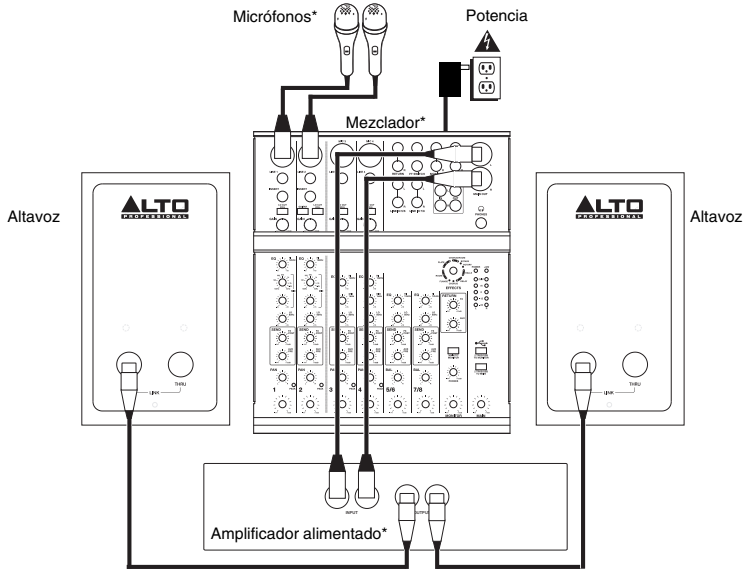

**Nota: No se incluyen micrófonos, mezclador, amplificador y cables.*

INSTALACIÓN

Este altavoz debe instalarse sobre un soporte colocado en el suelo, de acuerdo a su peso máximo, o suspendido de sus puntos de suspensión (M10 x 1.5PH, 30 mm de longitud) (vea la imagen de ejemplo). NO recomendamos suspender varios altavoces en un arreglo vertical.

Ejemplo:

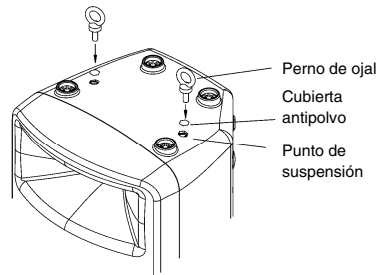

VISTA DEL PANEL TRASERO

1. **ENTRADA** – Use un cable Speakon* estándar (no incluido) para conectar su amplificador alimentado a esta entrada.
2. **CONEXIÓN PASANTE** – Use un cable Speakon estándar (no incluido) para conectar este conector a la entrada de otro altavoz.

* Speakon es una marca comercial de Neutrik® AG., registrada en EE.UU. y otros países

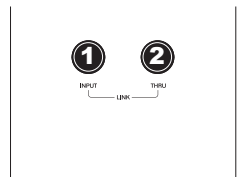

CONTENU DE LA BOÎTE

- Haut-parleur TOURMAX
- Guide d'utilisation simplifié
- Consignes de sécurité et informations concernant la garantie

SCHÉMA DE CONNEXION

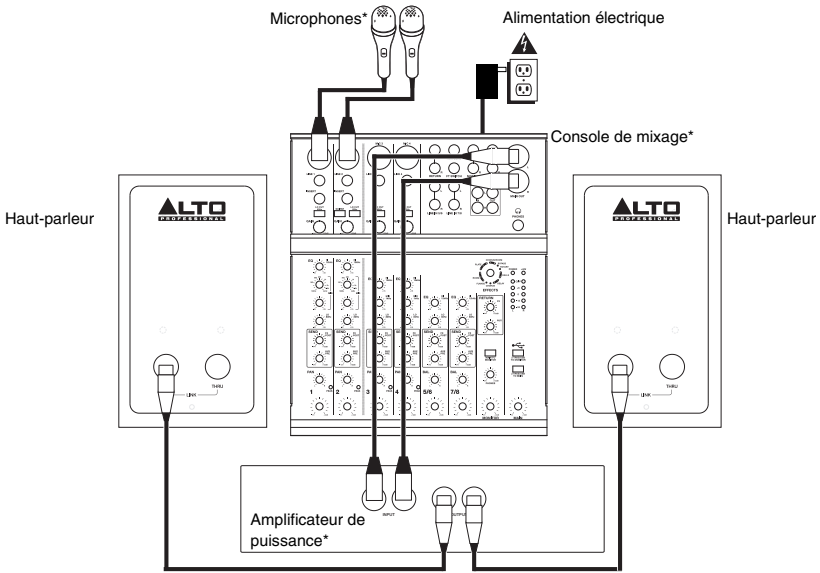

*Remarque : Microphones, câbles, console de mixage, amplificateur non inclus.

INSTALLATION

Ce haut-parleur doit être installé sur un pied sur le plancher, en fonction de son poids maximum, ou suspendu par ses points d'ancrage (M10 x 1,5 PH, 30 mm de longueur) (Consultez l'image). Nous NE RECOMMANDONS PAS de suspendre plusieurs haut-parleurs ensemble.

Exemple :

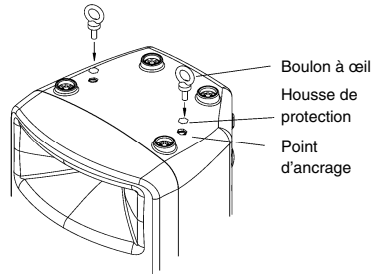

CARACTÉRISTIQUES DU PANNEAU ARRIÈRE

1. **ENTRÉE** – Utilisez un câble Speakon* standard (non inclus) pour brancher l'amplificateur de puissance à cette entrée.
2. **SORTIE RELAIS** – Utilisez un câble Speakon standard (non inclus) pour brancher cette sortie à l'entrée d'un autre haut-parleur.

* Speakon est une marque de commerce déposée de Neutrik® AG, enregistrée aux États-Unis et dans d'autres pays.

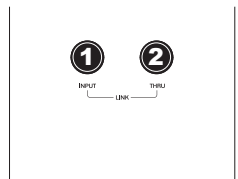

CONTENUTI DELLA CONFEZIONE

- Altoparlante TOURMAX
- Guida rapida
- Istruzioni di sicurezza e garanzia

SCHEMA DEI COLLEGAMENTI

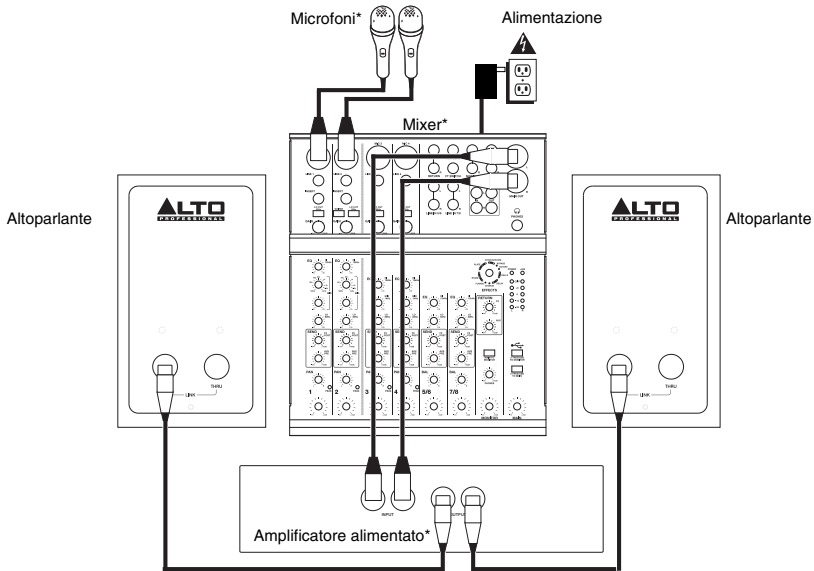

**Nota bene: microfoni, mixer, amplificatore e cavi non in dotazione.*

INSTALLAZIONE

Questo altoparlante deve essere installato su un supporto da pavimento, in base al suo peso massimo, oppure appeso servendosi degli appositi punti di sospensione (M10 x 1,5PH, 30 mm di lunghezza) (si veda l'immagine di esempio). NON si consiglia di sospendere più altoparlanti in verticale.

Esempio:

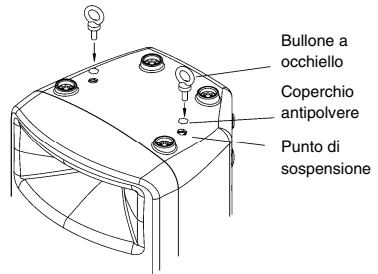

PANORAMICA PANNELLO POSTERIORE

1. **INGRESSO** – Servirsi di un cavo standard Speakon* (non in dotazione) per collegare un amplificatore alimentato a questo ingresso.
2. **THRU** – Servirsi di un cavo standard Speakon (non in dotazione) per collegare questo jack all'ingresso di un altro altoparlante.

* Speakon è un marchio di fabbrica di Neutrik® AG, registrato negli Stati Uniti e in altri Paesi.

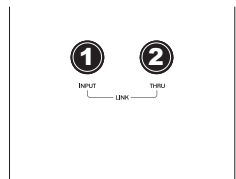

LIEFERUMFANG

- TOURMAX Lautsprecher
- Schnellstart-Anleitung
- Sicherheitshinweise und Garantieinformationen

ANSCHLUSSÜBERSICHT

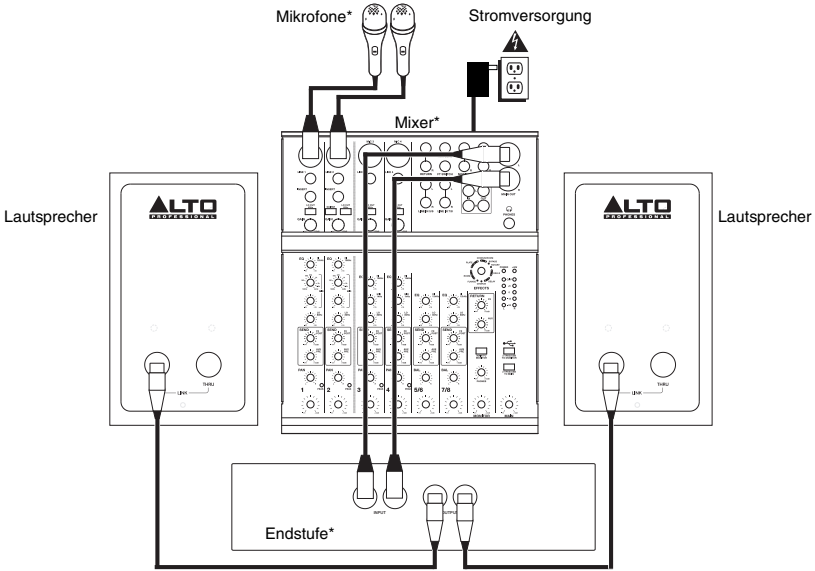

**Hinweis: Mikrofone, Mixer, Verstärker und Kabel sind nicht im Lieferumfang enthalten.*

MONTAGE

Dieser Lautsprecher sollte seinem Maximalgewicht entsprechend auf einem Bodenstativ montiert oder an den Aufhängepunkten aufgehängt werden (M10 x 1.5PH, 30mm Länge) (siehe Beispielbild). Mehrere Lautsprecher vertikal aufzuhängen ist NICHT empfehlenswert.

Beispiel:

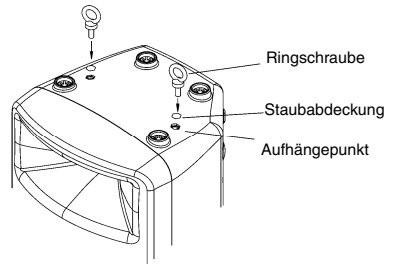

ÜBERSICHT RÜCKSEITE

1. **EINGANG** – Verwenden Sie ein handelsübliches Speakon*-Kabel (nicht im Lieferumfang enthalten), um Ihre Endstufe an diesen Eingang anzuschließen.
2. **THRU** – Verwenden Sie ein handelsübliches Speakon-Kabel (nicht im Lieferumfang enthalten), um diese Buchse mit dem Eingang eines anderen Lautsprechers zu verbinden.



* Speakon ist ein Warenzeichen der Neutrik® AG und ist in den USA und anderen Ländern eingetragen.

INHOUD VAN DE DOOS

- TOURMAX luidspreker
- Snelstartgids
- Veiligheidsvoorschriften & boekje met informatie over de garantie

VERBINDINGSDIAGRAM

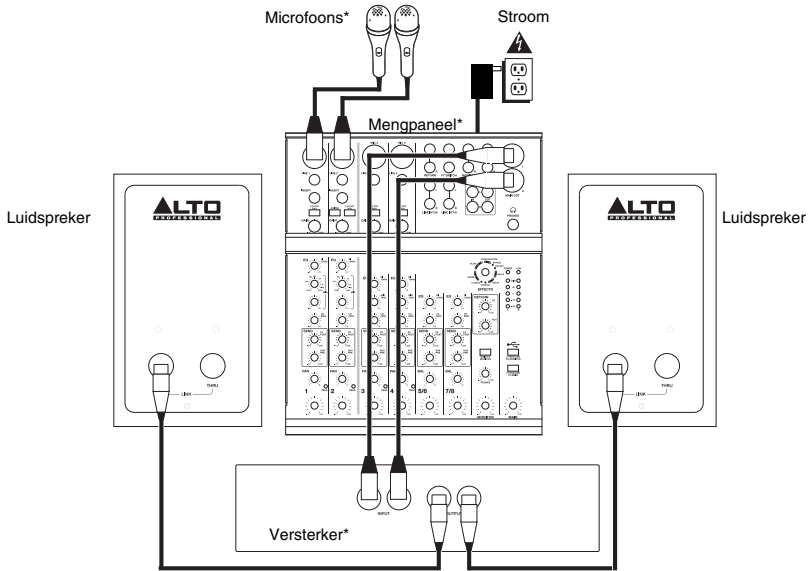

**Opmerking: Microfoons, mengpaneel, versterker en kabels zijn niet inbegrepen.*

INSTALLATIE

Deze luidspreker dient te worden geplaatst op een vloerstatief aangepast aan het maximumgewicht, of opgehangen aan zijn ophangpunten (M10 x 1.5PH, 30 mm lengte) (zie afbeelding als voorbeeld). Wij raden u NIET aan meerdere luidsprekers in een verticale opstelling op te hangen.

Voorbeeld:

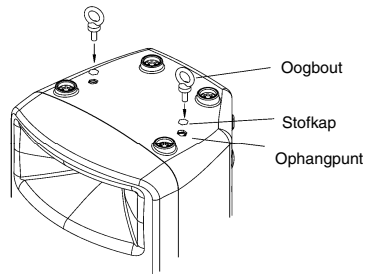

OVERZICHT ACHTERPANEEL

1. **INPUT** – Gebruik een standaard Speakon-kabel* (niet meegeleverd) om uw versterker met deze ingang te verbinden.
2. **THRU** – Gebruik een standaard Speakon-kabel (niet meegeleverd) om deze aansluiting te verbinden met de ingang van een andere luidspreker.

* Speakon is een handelsmerk van Neutrik® AG, geregistreerd in de VS en andere landen.

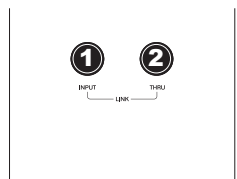

SPECIFICATIONS

Output power:	200 W Continuous RMS, 400 W Program, 800 W Peak
Crossover:	2 kHz (@ 12 dB/Oct)
Max SPL @ 1m:	119 dB Continuous, 122 dB Peak
Frequency Response:	65 Hz – 20 kHz (@ -10 dB)
Nominal Impedance:	8Ω
Low Frequency:	12" (385mm) woofer, 2" (51 mm) voice coil
High Frequency:	1" (25 mm) neodymium driver, 1" (25 mm) voice coil
Connectors:	Input: Speakon* Link: Speakon
Cabinet:	Trapezoidal, composite wood, black paint finish
Coverage:	90° H x 60° V Elliptical wave guide
Dimensions (H x W x D):	25.6" x 15.7" x 14.4" (650 mm x 400 mm x 365 mm)
Weight (speaker only):	43.9 lbs (19.9 kg)

* Speakon is a trademark of Neutrik® AG, registered in the U.S. and other countries.



THIS DEVICE COMPLIES WITH PART 15 OF THE FCC RULES. OPERATION IS SUBJECT TO THE FOLLOWING TWO CONDITIONS: (1) THIS DEVICE MAY NOT CAUSE HARMFUL INTERFERENCE, AND (2) THIS DEVICE MUST ACCEPT ANY INTERFERENCE RECEIVED, INCLUDING INTERFERENCE THAT MAY CAUSE UNDESIRE OPERATION.

www.altoprofessional.com